

Program Thermostat Owners Manual

ModeCP2815

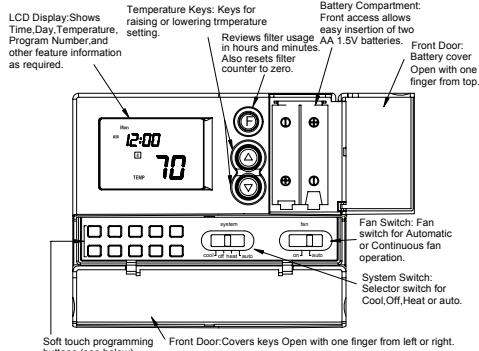

FEATURES

Structure of thermostat and explanation for the keypads

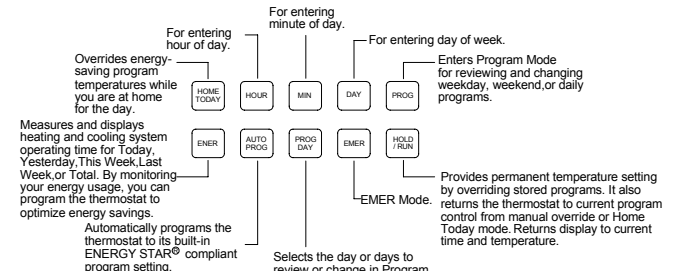

We are pleased you have selected one of our broad line of wall thermostat. Our products are manufactured to high quality standards and are designed for years of service.

Read This Before Installing Thermostat

OPERATION

YOUR THERMOSTAT REPLACES	
Description	CP2815
Heat Pump (No Aux. or Emergency Heat)	Yes
Heat Pump (with Aux. or Emergency Heat)	Yes
Standard Heat & Cooling Systems	Yes
Two Stage Heat & Two Stage Cool	Yes
Standard Heat Only Systems	Yes
Millivolt Heat Only Systems- Floor or Wall Furnaces	Yes
Standard Central Air Conditioning	Yes
Gas or Oil Heat	Yes
Electric Furnace	Yes
Hydronic (Hot Water) Zone Heat-2 Wires	Yes
Hydronic (Hot Water) Zone Heat-3 Wires	No

This Thermostat will NOT control 110/220Volt systems.

IMPORTANT

2. Read the entire installation section of this Owner's Manual thoroughly before you begin to install or operate your Thermostat. REMOVE THE MYLAR LABEL FROM THE LCD DISPLAY WINDOW.

INSTALLATION

3. All installation is normally performed at your thermostat.

ARMCHAIR PROGRAMMING

4. You can program your thermostat before installation by inserting the batteries and following the instructions starting configuration menu. This can be done while you relax in your favorite chair and is a very good way to familiarize yourself with all the functions of your thermostat.

The following time and temperature settings are pre-programmed into the thermostat:

Program Number	Time	Temperature in F° (C°)	
		Heat	Cool
1	6:00 am	68° F (20° C)	78° F (26° C)
2	8:00 am	60° F (16° C)	85° F (29° C)
3	4:00 pm	68° F (20° C)	78° F (26° C)
4	10:00 pm	60° F (16° C)	82° F (28° C)

COMPRESSOR PROTECTION

5. The thermostat provides a 4 minutes delay after shutting of the heating or cooling system before it can be restarted. This feature will prevent damage to your compressor caused by rapid cycling. Note that this delay also applies to the heating system control. It does not provide a delay when there are power outages, you can select the function on or off at the configuration.

TEMPERATURE RANGE

6. This thermostat can be programmed between 45°F and 95°F (7°C and 35°C). However, it will display room temperatures from 30°F to 99°F (0°C and 37°C). "HI" will be displayed if the temperature is higher than 99°F (37°C), and "LO" will be displayed if the temperature is lower than 30°F (0°C). This thermostat will automatically cutoff in Heat mode if the temperature rises above 95°F (35°C), and automatically cutoff in Cool mode if the temperature drops below 45°F (7°C).

NOTE: The thermostat will automatically change to the Cool mode if the thermostat measure a temperature over 99°F (37°C), "HI" will be displayed on the LCD, and the Cooling system will turn On. Similarly, the thermostat will automatically change to the Heat mode if the temperature is below 32°F (0°C), and "LO" will be displayed on the LCD, and the Heating system will turn On.

POWER FAILURE

7. Whenever the main power is interrupted or fails, the battery power retains and current time. This thermostat has permanent memory, although you will have to reset your clock when there are power outages.

POWER SUPPLY

8. The thermostat shall be powered by 24 VAC and with batteries as backup.

BATTERY WARNING

9. Fresh alkaline batteries should provide about one year of service. However, when the batteries become drained, "BATT" will alternate on the display with the current time. When this message occurs, install 2 new AA batteries. You have approximately 1 minute to change the batteries and keep thermostat's clock and program settings. Once the batteries have become too low to ensure proper operation, your system will be turned off, and the display will be cleared except for "BATT" flashing on the LCD display.

CAUTION: Once only the "BATT" only display occurs, the thermostat is shut down, and your system will no longer operate. In this condition, there is no temperature control of your dwelling. NOTE: The backlight will not function when the thermostat is in low battery condition.

NOTE: If you plan to be away from the premises over 30 days, we recommend that you replace the old batteries with new alkaline batteries prior to leaving.

INSTALLATION

What You Need

This thermostat includes two #8 slotted screws and two wall anchors for mounting. To install your thermostat, you should have the following tools and materials.

- Slotted Screwdriver(s)
- Small Philips screwdriver
- Hammer
- Electric drill and 3/16" bit
- Two 1.5V (AA) size alkaline batteries (included)

CAUTION:

To prevent electrical shock and/or equipment damage, age, disconnect electric power to system at main fuse or circuit breaker box until installation is complete.

Before removing wires from old thermostat's switching subbase, label each wire with the terminal designation it was removed from.

1. Shut off electricity at the main fuse box until installation is complete. Ensure that electrical power is disconnected.

2. Remove Old Thermostat: A standard heat/cool thermostat consists of three basic parts:

- The cover, which may be either a snap-on or hinge type.
- The base, which is removed by loosening all captive screws.
- The switching subbase, which is removed by unscrewing the mounting screws that hold it on the wall or adaptor plate.

3. Remove the front cover of the old thermostat. With wires still attached, remove wall plate from the wall. If the old thermostat has a wall mounting plate, remove the thermostat and the wall mounting plate as an assembly.

4. Identify each wire attached to the old thermostat.

5. Disconnect the wires from the old thermostat one at a time. DO NOT LET WIRES FALL BACK INTO THE WALL.

6. Install new thermostat using the following procedures.

WARNING

Do not use on circuits exceeding specified voltage. Higher voltage will damage control and could cause shock or fire hazard. Do not short out terminals on gas valve or primary control to test. Short or incorrect wiring will damage thermostat

and could cause personal injury and/or property damage.

Selector Switches

Electric/Gas Switch (Fan Option)

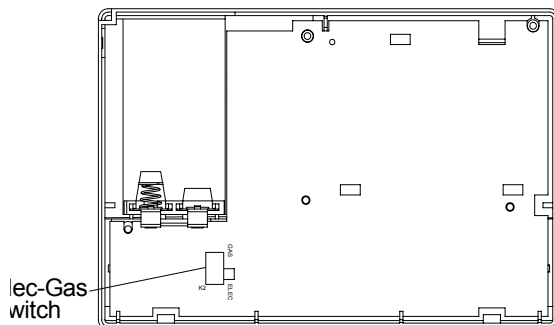

Figure 1. Electric/Gas Switch (Fan Option)

This thermostat is configured from the factory to operate a heat/ cool, fossil fuel (gas, oil, etc.), forced air system. It is configured correctly for any system that DOES NOT require the thermostat to energize the fan on a call for heat. If you system is an electric heat or heat-pump system that requires the thermostat to turn on the fan on a call for heat, locate the ELEC/GAS switch on the back of the thermostat (see fig. 1) and switch it to the ELEC position. This will allow the thermostat to energize the fan immediately on a call for heat. If you are unsure if the heating/ cooling system requires the thermostat to control the fan, contact a qualified heating and air conditioning service person. When the thermostat is configured for Heat Pump, the thermostat will always power the circulator fan on a call for heat in the HEAT mode. The ELEC/GAS switch must be set to match the type of Auxiliary heat your system uses for proper operation in the EMERGENCY mode. All wiring diagrams are for typical systems only. Refer to equipment manufacturers' instructions for specific system wiring information.

Attach Thermostat Base to Wall

1. Remove the packing material from the thermostat. Gently pull the cover straight off the base. Forcing or prying on the thermostat will cause damage to the unit.
2. Connect wires beneath terminal screws on base using appropriate wiring schematic (see figs. 2 through 4).
3. Place base over hole in wall and mark mounting hole locations on wall using base as a template.
4. Move base out of the way. Drill mounting holes.
5. Fasten base loosely to wall, as shown in fig. 1, using two mounting screws. Place a level against bottom of base, adjust until level, and then tighten screws. (Leveling is for appearance only and will not affect thermostat operation.) If you are using existing mounting holes, or if holes drilled are too large and do not allow you to tighten base snugly, use plastic screw anchors to secure subbase.
6. Push excess wire into wall and plug hole with a fire-resistant material (such as fiberglass insulation) to prevent drafts from affecting thermostat operation.

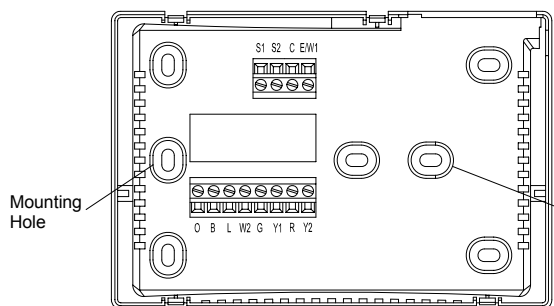

Figure 2. Thermostat base

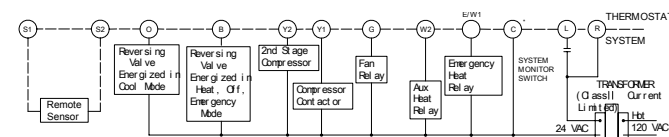

Figure 3 Typical wiring diagram for single transformer heat pump systems

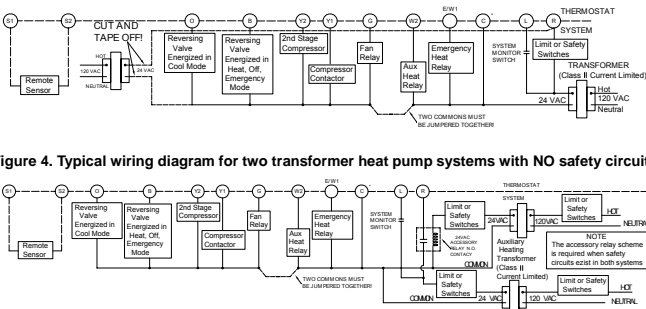

Figure 4 Typical wiring diagram for two transformer heat pump systems with NO safety circuits

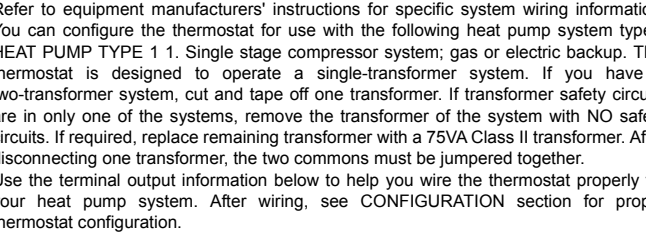

Figure 5 Typical wiring diagram for two transformer heat pump systems with safety circuits in BOTH systems

Heat Pump Terminal Outputs

Refer to equipment manufacturers' instructions for specific system wiring information. You can configure the thermostat for use with the following heat pump system types:

THERMOSTAT TERMINALS (HEAT PUMP)	
SYSTEM	Heat Pump 1
L	Malfunction
C*	24 Volt(Common)
R	24 Volt Emergency (hot)
E/W1	Emergency Mode 1st stage
W2	HP 1 and Emergency 2nd stage
Y1	Heat and Cool mode 1st stage (compressor)
Y2	No output 2nd stage compressor
G	Blower/Fan Energized on call for Heat and Cool Set GAS/ELEC switch for Emergency mode
O	Energized in Cool Mode
B	Energized in Heat Emergency mode

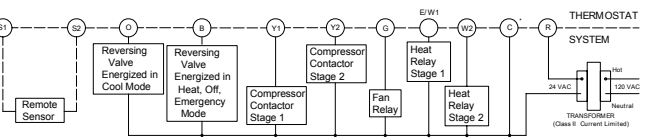

Figure 5 Typical wiring diagram for single transformer multi-stage systems

CHECK THERMOSTAT OPERATION

Note:

To prevent static discharge problems, touch side of thermostat to release static build-up before touching any keys.

If at any time during testing your system does not operate properly, contact a qualified servicetperson.

Fan Operation

If your system does not have a G terminal connection, skip to Heating System System.

1. Turn on power to system.
2. Move FAN switch to ON position. The blower should begin to operate.
3. Move FAN switch to AUTO position. The blower should stop immediately

Heating System

1. Move system switch to heat mode. If the auxiliary heating system has a standing pilot, be sure to light it.

2. Press to adjust thermostat setting to 1°C above room temperature. The heating system should begin to operate. The display should show "STG1". However, if the setpoint temperature display is flashing, the compressor lockout feature is operating (see Configuration menu, item 5).

3. Adjust temperature setting to 3° above room temperature. If your system configuration is set at MS2, HP2 or HP1, the auxiliary heat system should begin to operate and the display should show "STG1+2" 2".

4. Press to adjust the thermostat below room temperature. The heating system should stop operating.

Emergency System

EMER bypasses the Heat Pump to use the heat source wired to terminal E on the thermostat. EMER is typically used when compressor operation is not desired, or you prefer back-up heat only.

1. Press SYSTEM switch to select Heat mode. then press EMER key. "EMER" will show on the display.
2. Press to adjust thermostat setting above room temperature. The Aux. heating system will begin to operate. The display will show "STG1" "EMER" to indicate that the Aux. system is operating.

3. Adjust temperature setting to 2°C above room temperature. The auxiliary heat system should begin to operate and the display should show "STG1+2".

4. Press to adjust the thermostat below room temperature. The Aux. heating system should stop operating.

Cooling System

1. Move SYSTEM switch to select the Cool mode.

2. Press to adjust thermostat setting below room temperature. The blower should come on immediately on high speed, followed by cold air circulation. The display should show "STG1".

3. Adjust temperature setting to 2°C below room temperature. The second stage cooling should begin to operate and the display should show "STG1+2"

4. Press to adjust the temperature setting above room temperature. The cooling system should stop operating.

CONFIGURATION MENU

INSTALLER/CONFIGURATION MENU				
Step	Press Button	Displayed (Factory Default)	Press up or down key to select	Comments
1	F	MS 2	SS1, HP2, HP1	Selects Single stage, Multi-stage, or Heat Pump (Single stage or 2-stage) System Configuration
2	F	(RECO)off	on	Auto Recovery select
3	F	(SPAN)2	1,3	Span(one stage)
4	F	(BLIT)on	off	BackLight
5	F	(SP2)2	1,3	Span(Two Stage)
6	F	(TEMP)F	C	Selects temperature display F° or C°
7	F	HOUR(12)	24	Selects time format display 12hours or 24hours
8	F	COMP(OFF)	ON	Selects Compressor Lockout OFF or ON
9	F	COOL(2)	2	This model must select 2
10	F	FACT(0)	1,2	This model must select 2 to back factory Default

The configuration menu allows you to set certain thermostat operating characteristics to your system or personal requirements. Set SYSTEM switch to OFF, then simultaneously press up and down keys to enter configuration menu. The display will show the first item in the configuration menu. The configuration menu table summarizes the configuration options. An explanation of each option follows. Press F key to change to the next menu item. To exit the menu and return to the program operation, press Hold/Run Key. If no keys are pressed within fifteen Seconds, the thermostat will revert to normal operation.

1) Single Stage, Multi-stage or Heat Pump System Configuration

This control can be configured for Heat Pump or two stage heat/one stage cool multi-stage operation. The display indicates "MS 2" (default for multi-stage mode) in the display. The Multi-stage configuration can be toggled to "SS1", or "HP1" by pressing the up or down key. In Multi-stage configuration, EMER mode is useless in this model. The "HP2" is no use.

2) Select Energy Management Recovery OFF or ON

Your thermostat is set from the factory to gradually recover the room temperature from an energy saving program to your comfort program. Therefore, the thermostat may turn your system on several minutes prior to your programmed.

3) Fast or Slow Cycle Selection(one stage)

4) Select Backlight function OFF or on

5) Fast or Slow Cycle Selection(two stage)

6) Select F° or C° Readout. when you change this parameter, the programming come back to fault, you have to set the programming again.

Changes the display readout to Centigrade or Fahrenheit as required

7) Selects time format display 12hours or 24hours

8) Select Compressor Lockout COMP OFF or ON

Selecting COMP ON will cause the thermostat to wait 4 minutes before turning on the compressor if the heating and cooling system loses power. It will also wait 5 minutes minimum between cooling and heating cycles. This is intended to help protect the compressor from short cycling. Some newer compressors already have a time delay built in and do not require this feature. Your compressor manufacturer can tell you if the lockout feature is already present in their system. When the thermostat compressor time delay occurs it will flash the setpoint for about four minutes.

9) This model must select 2

10) This model must select 2 to back factory Default

Setting Time And Day

Remove the mylar label covering the LCD display window before operating thermostat.

- Initial display after power-up. The temperature will update after a few seconds.

EXAMPLE: Set the Thermostat to the current time of 9:43 a.m. on Saturday Refer to Figure at right

- During time and day setting mode, the temperature and program display will go blank.

- Press and hold to rapid advance to the current hour.

- Tap to advance one hour at a time. Note the AM /PM indicator, as the display will cycle through 24 hours.

- Press and hold to rapid advance to the current minute.

- Tap to advance one minute at a time.

- Tap to advance one day at a time.

- When finished press to return to normal mode.

- After 15 seconds, the thermostat will return to normal automatically.

Auto Programming

Studies conducted by the Department of Energy estimate that setting your thermostat back 10°F (6°C) for two 8-hour periods during winter can reduce your fuel bill by as much as 33%.

By setting your thermostat up 5°F (3°C) for two 8-hour periods during summer you can reduce your fuel bill up to 25%.

Your thermostat is capable of holding up to 4 separate programs for each day of the week. You can program all weekdays, Monday to Friday, to the same 4 programs as show in the table, or each weekday can have a different set of 4 programs. Similarly weekend programs, Saturday and Sunday, can be the same 4 programs or each weekend day can have a different set of 4 programs.

Your thermostat is pre-programmed to meet the ENERGY STAR guidelines for energy efficiency. Note that it is easier to modify these programs than to program the thermostat manually.

- Press once. During Auto Programming, the display will change as shown.
- The thermostat will be programmed for all 7 days of the week as shown below.

Program Number	Time	Temperature in F°/C°	
		Heat	Standard
1	6:00am	68° F (20°C)	78° F (26°C)
2	8:00am	60° F (16°C)	85° F (29°C)
3	4:00pm	68° F (20°C)	78° F (26°C)
4	10:00pm	60° F (16°C)	85° F (29°C)

PROGRAMMING

Before programming or changing programs, use this Personal Program Schedule to determine which times and temperature Settings will best satisfy both your comfort and energy saving requirements. Use a pencil so you can revise yours records each time you change your temperature settings.

Heating

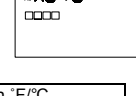
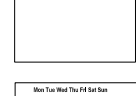

DAY	Program1	Program2	Program3	Program4
Mon.	Time Temp	Time Temp	Time Temp	Time Temp
Tue.	Time Temp	Time Temp	Time Temp	Time Temp
Wed.	Time Temp	Time Temp	Time Temp	Time Temp
Thu.	Time Temp	Time Temp	Time Temp	Time Temp
Fri.	Time Temp	Time Temp	Time Temp	Time Temp
Sat.	Time Temp	Time Temp	Time Temp	Time Temp
Sun.	Time Temp	Time Temp	Time Temp	Time Temp

Cooling

DAY	Program1	Program2	Program3	Program4
Mon.	Time Temp	Time Temp	Time Temp	Time Temp
Tue.	Time Temp	Time Temp	Time Temp	Time Temp
Wed.	Time Temp	Time Temp	Time Temp	Time Temp
Thu.	Time Temp	Time Temp	Time Temp	Time Temp
Fri.	Time Temp	Time Temp	Time Temp	Time Temp
Sat.	Time Temp	Time Temp	Time Temp	Time Temp
Sun.	Time Temp	Time Temp	Time Temp	Time Temp

Manual Programming

Your thermostat can be programmed for weekdays and weekends, or have unique programs for all 7 days. Use Weekday /Weekend Programs or 7-day Programming to enter or revise programs to match your Personal Program Schedule. The same steps are used when entering programs for the first time, or revising programs entered during Auto Programming.

Familiarize yourself with Manual Programming, so that you can easily modify your programs as your comfort needs change. The example below demonstrates the Manual Programming method.

NOTE:

- The program time can be set in 10-minute increments, and remains the same for both Heat and Cool programs.
- The program temperature can be set in increments of 1°F (1°C).
- The Heat setpoint can not be set higher than the Cool set point, and the Cool set point can not be set lower than the Heat set point.
- If the system selector is in AUTO mode, the current operating mode will be used for programming.
- After 15 seconds without a key press, the thermostat will return to normal display mode.
- When setting the program time, note the AM/PM indicator.
- With the Auto Recovery feature enabled, you do not need to set your comfort program times early. Auto Recovery will determine how early Recovery will determine how early to turn your system on, so that the room is comfortable at the program time.

Weekday/Weekend Programming

Weekday Programs

Press	Display Reads
<ul style="list-style-type: none"> Normal display of time, temperature, and day of the week. 	
Step 1 PROG DAY <ul style="list-style-type: none"> Selects days Mon to Fir for same set of 4 programs each day. 	
Step 2 PROG <ul style="list-style-type: none"> Program indicator(1) is displayed. 68°F is displayed. Mon to Fir is displayed. 	
Step 3 HOUR <ul style="list-style-type: none"> Press and hold until 6:00 is displayed. Note AM/PM 	
Step 4 (Up Arrow) (Down Arrow) <ul style="list-style-type: none"> Press once to change temperature to 69°F. Weekday program 1 is complete. Press PROG to move to program 2,3, and 4 and follow the same steps. 	
Use HOUR MIN (Down Arrow) (Up Arrow) to insert or change time and temperature of other programs.	
PROG DAY <ul style="list-style-type: none"> Selects weekend days Sat, Sun for same set of 4 programs each weekend day. Follow steps 2-4 to enter programs. 	

Similar to weekday programming.

PROG HOUR MIN (Down Arrow) (Up Arrow) to insert weekend programs.

Individual Day Programming

To program for each individual day separately by a different set of programs, first select day by displaying the day of program, then insert the desired times and temperatures.

Press	Display Reads
PROG DAY <ul style="list-style-type: none"> Mon to Fir are selected. Mon to Fir will have Same programs. 	
PROG DAY <ul style="list-style-type: none"> Sat to Sun will have Same programs. 	
PROG DAY <ul style="list-style-type: none"> Mon is selected, program for Mon only. 	

Use PROG DAY HOUR MIN (Down Arrow) (Up Arrow) to enter programs for Monday.

Similarly PROG DAY
 ■ Tue to Sunday can be selected.

Display the day to be programmed and use PROG DAY HOUR MIN (Down Arrow) (Up Arrow) to enter programs.

NOTE: Another approach to programming is to first program all weekdays Mon through Fir and Sat and Sun as same programs. Then, display and change the programs of only those days which will have different programs.

Reviewing Programs

You may want to review the programs to see that the settings are compatible with your lifestyle.

- Normal display of current time, day of week temperature, and day of week.



- 1st weekday program is displayed.
- Program indicator(1) appears.
- Mon to Fir indication appears.
- Continue pressing PROG DAY to view each day.
- Continue pressing PROG to view each period.

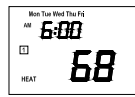

If you are armchair programming the thermostat, before you mount the face of the thermostat, turn the system selector to the OFF position.

Reviewing the Current Temperature Setting

Current time and temperature.

- Press less than 1 second.
- Set Temperature is shown above current room temperature.

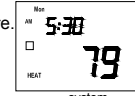

OPERATION

System Selector Switch

The System Selector Switch on the front of the thermostat determines the Operating mode of the thermostat. You may select COOL ,OFF , HEAT,AUTO. In order to take full advantage of this thermostat's feature, we recommend using the AUTO mode. Refer to the Auto Season Changeover information on Auto Season Changeover.

NOTE: Anytime you install or remove the thermostat from the wallplate, slide the System Selector to the OFF position to prevent the possibility of a rapid system On-Off.

Fan Switch

The Fan switch should normally be located in the AUTO position. The Fan will be turned on along with normal operation of your system. In a normal gas or oil furnace, the Fan will be turned on by your furnace after its warm-up delay. For electric heat, air conditioning, and heat pump operation, the Fan will turn on with the system. To run the Fan on continuously, slide the Fan switch to the ON position.

Temporary Manual Override

To temporarily change the current set temperature without affecting your program:

- Press and hold (Up Arrow) or (Down Arrow) for less than 1 second to enter Manual Override mode.

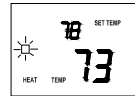

- Press (Up Arrow) and (Down Arrow) to change to your desired new temperature.

- Press to RUN to normal mode or wait 15 seconds for it to return automatically.
- The current program number will flash to signify the Temporary Override. At the next program change, the Temporary Override is canceled, and the next program temperature becomes the setpoint temperature.

To end the Temporary Manual Override:

- Press and wait for HOLD to display on the lcd.
- Press HOLD key twice. This will return the set temperature to the current program set temperature.

NOTE: The Auto Season Changeover feature will not operate while the thermostats is in Temporary Manual Override. Refer to the Auto Season Changeover feature for more information.

Permanent Override or a Designated Day Override

To hold your Manual Override for vacation or Until a Designated Day.

- Press to make the current program temperature the HOLD temperature. HOLD will be displayed on the LCD, and the Program number will disappear.
- Follow the Temporary Manual Override instructions above to change the Permanent Manual Override temperature.
- You can confirm the held set temperature by pressing for less than 1 second.
- Press again. Hold day will be displayed on the lcd and the clock will disappear
- Press Day key to add override days. Press Hour key to reduce override days
- Follow the Temporary a Designated Day Override instructions above to change the Permanent Manual Override temperature.

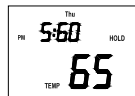

To end Override:

Under Permanent Override Press hold/return key twice. Under a Designated Day Override press the hold once. The thermostat will return to the current program, and the HOLD display will be canceled.

NOTE: The Auto Season Changeover feature will not operate while the thermostat is in permanent Manual Override. Refer to the Auto Season Changeover feature for more information.

Auto Season Changeover

When the System Selector is in AUTO position , the thermostat will automatically change between Heating and Cooling systems, depending on your program. We recommend keeping your programmed heating and cooling temperature at least 4°F (2°C) apart to allow the Auto Season Changeover to occur when the appropriate temperature span has been reached. However, if your heating and cooling programs set temperatures are close, there is a built-in program to prevent the thermostat is in Temporary, a Designated Day Override or Permanent Override, as these overrides are energy saving settings. Auto Season Changeover will still function in Home Today mode, as this is a comfort setting.

For example, you may have the following temperatures programmed at a given time: Heat Set Temp=68°F, Cool Set Temp=78°F

If the room temperature rises above 78°F, then the thermostat will automatically change to cool mode and turn on the air conditioner.

Likewise, the thermostat will automatically change to heat mode and turn on heat when the room temperature falls below 68°F.

HOME TODAY

This patent pending feature allows you to quickly and Temporarily Override your energy saving program setting on days when you are normally away from home with one key press.

- Press to enter the Home Today override .The highest program temperature for today will be selected from your programs in Heat mode and become the set temperature.(In Cool mode ,Home Today will select the lowest program temperature for today to be the set temperature.)
- The display will alternate between "HOME" and the current time.

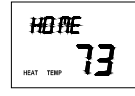

When pressed during the day, the thermostat will remain in Home Today mode until the first program of the next day.

If the system is changed between Heat and Cool modes (either manually or by Auto Season Changeover) during the "Home Today" override period, the setpoint temperature will be automatically update. It will automatically change from the lowest cool program setpoint to the highest heat program setpoint.

Press to exit Home Today mode before the schedule ending time. "HOME" is no longer displayed on the LCD screen, and the thermostat returns to the current program.

- You can manually change the setpoint temperature while in Home Today mode. Refer to the Temporary Manual Override instructions .Manually changing the set temperature while in Home Today mode will not affect the Home Today ending time. However, the set temperature will not change automatically with a manual or Automatic change between heating and cooling.

Energy Monitor

The Energy monitor feature measures and stores the amount of time the heating and air conditioning system operates. Usage can be display for Today (since 12 am), Yesterday, This Week (since Monday), Last Week (last Monday through Sunday), and Total (up to 999 Hrs). By monitoring your energy usage, you see how much the set-back periods are saving, and you can test program adjustment to save even more. To review energy usage, press to cycle through Today, Yesterday, This Week, Last Week, and Total. Press again to return to normal mode, or wait 15 seconds for the display to return to normal mode .You can also return to normal mode at any time by pressing RUN.

- For example: This LCD display shows Today's usage to be 10 Hours, 26 minutes.
- Press and hold for 3 seconds to reset the Energy Monitor's counters. The display will blink, and counters will be cleared to zero.



NOTE: Clearing the Energy Monitor counter will also clear the Filter Monitor counter , as

Filter usage and Total Energy usage are the same. Also, clearing the filter Monitor counter will clear ALL Energy Monitor counters as well.

Filter Monitor

Your thermostat also keeps a record of the number of hours your filter has been in use. To maximize your system's performance and energy efficiency, change or clear your filter regularly.

When the total system run time for heat and cool reaches 500 hours, you need clean or change your system's filter, "FILT" will continue to flash until the counter is set back to zero.

Press to review total filter usage. The display will blink "FILT" Then show the filter Monitor counter. After 15seconds, the display will return to normal mode, or you can hit RUN to exit immediately.

The Filter Monitor will display up to 999 hours and 59 minutes of usage. In this example, the counter is at 410 Hours, 26 minutes.

To reset the Filter Monitor counter, depress FILTER for 3 seconds. The display will blink, and the counter will be reset to zero.

NOTE: Clearing the Filter Monitor counter will also clear ALL Energy Monitor counters, as Filter usage and Total Energy usage are the same. Also, clearing the Energy Monitor counters will clear the Filter Monitor counter as well.

Auto Recovery

Auto Recovery calculates how early to turn your system back on, so that the room temperature is already comfortable by the start of the comfort temperature program period. Auto Recovery work's in both Heat and Cool modes.

When the thermostat is in Auto Recovery mode, the display will alternate "RECO" with time, and the program indicator will flash.

Auto Recovery can be disabled by sliding the Recovery switch on the circuit board to disable.

Auto Recovery will not operate if Permanent hold or Temporary hold is in operation.

Auto Recovery can be canceled manually if HOLD is pressed during the recovery process.

Auto Recovery will be canceled and change to next period.

Details of Auto Recovery Operation:

- Auto Recovery can be disabled by sliding the Recovery switch on the circuit board to the DISABLE position.
- Today is in operation.
- Auto Recovery can be canceled manually if HOLD is pressed during the recovery process. If a recovery process is canceled manually then the recovery process will not start again until the next program period starts (an exception is that if time or program is changed then the thermostat will check Auto Recovery conditions immediately).
- Auto Recovery will be canceled and change to Home Today mode if HOME TODAY is pressed during the recovery process.

Keyboard lock
The keyboard can be locked to prevent unauthorized changes to the thermostat. To lock or unlock the keyboard, press and hold hold/run Key for 3 seconds.The keyboard is locked.when LOCK appears on the display.

All keys are locked, Any time a key is pressed, LOCK will appear on the display for 1 second.]

Remote Sensor

It is selectable between internal sensor and remote sensor. The internal sensor will be disable when S1-S2 terminal connect with remote sensor. The internal sensor is default if there's no remote sensor connect with terminals.

Backlighting

Your thermostat has an electroluminescent lamp that backlights the display for easy viewing in the dark.

When any key is pressed the display is illuminated. The display will remain illuminated for 8 seconds after the last key is pressed. This allows the light to stay on if you need to operate several keys.

NOTE: If the thermostat is in Low Battery warning condition, the backlight will not operate. Replace with 2 new AA alkaline batteries to restore the Backlight function.

Low Battery Warning

Your thermostat has a two-stage low battery warning system. When the batteries are first detected to be weak, the first stage low battery warning is indicated by "BATT" flashing on the LCD display. At your earliest convenience, you need to replace the batteries with 2 new AA alkaline batteries.

When the batteries become too weak for normal operation, the thermostat enters the second stage low battery warning which shuts down the thermostat. In this condition, "BATT" flashes alone on the display, and the thermostat will turn your system Off. Your system will remain shut-off until the batteries are replaced.

NOTE: The thermostat will still keep the current Set Temperature and Filter run time in memory until new batteries are installed. After confirming that new batteries have been inserted, the thermostat will return to normal operation.

Error Mode

If the thermostat is unable to control your system due to an unexpected battery problem, the thermostat will enter Error Mode. In this condition, the thermostat flashes "E1", "E2", "E3" or "E4" on the LCD display, and shuts off your system. To correct this problem, replace the batteries with 2 new AA alkaline batteries, even if you have recently replaced them. Move the battery out, and then hold any key to release the rest energy. Then place the battery again. You will need to reprogram your thermostat and confirm normal operation.

If Error Mode returns, please call us for further information.

Warning Mode

If the SYSTEM MONITOR SWITCH is close show the system have wrong.the thermostat flashes "E5" on the LCD display.

Auto Cut Off

Your thermostat will automatically cutoff in Heat mode if the room temperature rises above 95°F (35°C). It will cutoff in Cool mode if the room temperature drops below 40°F (4°C).

Note that if your system has malfunctioned and no longer responds to thermostat controls, the Auto Cut-Off will have no effect.

TROUBLESHOOTING

Problem	Solution
SCRAMBLED OR DOUBLE DISPLAY (numbers over numbers)	1. Remove clear mylar sticker.
NO DISPLAY	1. Check battery connections and batteries 2. Move the battery out, and then hold any key to release the rest energy. Then place the battery again.
ENTIRE DISPLAY DIMS	1. Replace Batteries
PROGRAM DOES NOT CHANGE AT YOUR DESIRE SETTING	1. Check that the time is set properly to "AM" or "PM" 2. Check that the thermostat is not in "HOLD" or "Home Today" mode. 3. Check for the correct day settings.
AUTO/FAN DOES NOT TURN ON	1. Move Elec/Gas selector to opposite position is in the correct position ("HEAT,""COOL" or "AUTO") 2. The thermostat may be in the AUTO Mode. Look for "AUTO" on the LCD display. If the Heat and Cool program temperature are close, then the thermostat requires a larger room temperature change before changing from Heat or Cool. 3. There may be as much as 4 minute delay before the Heat or Cool system turns On-wait and check. (Compressor protection delay). 4. Check your circuit breaks and switches to ensure there is power to the system. 5. Replace batteries. 6. Make sure your furnace blower door is closed properly. 7. If your system only uses 4-wires, be sure the jumper wire is installed between the RC and RH terminals. 8. Check the position of the Furnace or Heat Pump selector switches: Normal/O/B.
ERRATIC DISPLAY	1. Move the battery out, and then hold any key to release the rest energy. Then place the battery again.
IF UNIT CONTINUES TO OPERATE IN THE OFF POSITION	1. Replace unit
THERMOSTAT PERMANENTLY READS "E1","E2","E3", "E4"..	1. Replace unit.

If you experience any other problems, call us for technical assistance. The service number is 1-866-591-9898

